

HTS Customer Care Kits

User's Guide

For Research Use Only. Not for use in diagnostic or therapeutic procedures.

bdbiosciences.com
23-11165-00 Rev. A
1/2010



Becton, Dickinson and Company
BD Biosciences
San Jose, CA 95131
Tel 877.232.8995
Fax 800.325.9637
ResearchApplications@bd.com

Asia Pacific
Tel 65.6.861.0633
Fax 65.6.860.1593

Brazil
Tel 55.11.5185.9995
Fax 55.11.5185.9895
bdbiosciences.brasil@bd.com

Canada
Toll Free 888.259.0187
Tel 905.288.6000
Fax 888.229.9918
canada@bd.com

Europe
Tel 32.2.400.9895
Fax 32.2.401.7094
help.biosciences@europe.bd.com

Japan
Nippon Becton Dickinson Company, Ltd.
Toll Free 0120.8555.90
Tel 81.24.593.5405
Fax 81.24.593.5761

Mexico
Toll Free 01.800.236.2543
Tel 52.55.5999.8296
Fax 52.55.5999.8288
biocienciasmexico@bd.com

© 2010, Becton, Dickinson and Company. All rights reserved. No part of this publication may be reproduced, transmitted, transcribed, stored in retrieval systems, or translated into any language or computer language, in any form or by any means: electronic, mechanical, magnetic, optical, chemical, manual, or otherwise, without prior written permission from BD Biosciences.

The information in this guide is subject to change without notice. BD Biosciences reserves the right to change its products and services at any time to incorporate the latest technological developments. Although this guide has been prepared with every precaution to ensure accuracy, BD Biosciences assumes no liability for any errors or omissions, nor for any damages resulting from the application or use of this information. BD Biosciences welcomes customer input on corrections and suggestions for improvement.

BD, BD Logo and all other trademarks are property of Becton, Dickinson and Company. © 2010 BD

FCC Information

WARNING: Changes or modifications to this unit not expressly approved by the party responsible for compliance could void the user's authority to operate the equipment.

NOTICE: This equipment has been tested and found to comply with the limits for a Class A digital device, pursuant to Part 15 of the FCC Rules. These limits are designed to provide reasonable protection against harmful interference when the equipment is operated in a commercial environment. This equipment generates, uses, and can radiate radio frequency energy and, if not installed and used in accordance with the instruction manual, may cause harmful interference to radio communications. Operation of this equipment in a residential area is likely to cause harmful interference in which case the user will be required to correct the interference at his or her own expense.

Shielded cables must be used with this unit to ensure compliance with the Class A FCC limits.

This Class A digital apparatus meets all requirements of the Canadian Interference-Causing Equipment Regulations.

Cet appareil numérique de la classe A respecte toutes les exigences du Règlement sur le matériel brouilleur du Canada.

Compliance Information

NOTICE: This laboratory equipment has been tested and found to comply with the EMC and the Low Voltage Directives. This includes FCC, Part 15 compliance for a Class A Digital Device.

CAUTION: Any unauthorized modifications to this laboratory equipment may affect the Regulatory Compliance items stated above.

History

Revision	Date	Change Made
23-11165-00 Rev. A	1/2010	Initial release

Contents

Chapter 1: Overview of HTS Customer Care	1
About the HTS Customer Care Kits	1
Kit Configurations	2
When to Use the Kit	2
About the HTS	3
HTS Configurations	3
Location of Commonly Clogged Components	5
Safety and General Precautions	7
Biological Safety	7
Electrical Safety	7
Precautions	7
Chapter 2: HTS Removal and Reinstallation	9
BD FACSCanto II System	9
Removing the HTS	9
Reinstalling the HTS	11
BD FACSCanto, BD LSR II, BD FACSCalibur, and BD LSRFortessa Systems	12
Removing the HTS	12
Reinstalling the HTS	15
Chapter 3: Wash Station Assembly Replacement	17
Required Kit Components	17
Replacing Wash Station Components	18
Assembling the Sample Injection Tubing Assembly	20

Chapter 4: Tubing Assembly Replacement	23
Required Kit Components	23
Replacing Tubing Assembly Components	24
Chapter 5: Sample Coupler and Tubing Replacement	27
BD FACSCanto and FACSCanto II Systems	28
BD FACSCalibur, BD LSR II, or BD LSRFortessa Systems	30
Chapter 6: Pump Syringe Replacement	31
Required Kit Components	32
Pump Syringe Replacement Procedures	32
Removing Liquid from the Syringe (For Primary Pump Syringe)	32
Replacing the Syringe	33
Chapter 7: Fluidic Connection and In-line Fluidic Filter Replacement	37
Required Kit Components	38
Replacing the Filters	39
Chapter 8: Probe and Probe Tubing/Body Assembly Replacement	41
Required Kit Components	41
Replacing the Probe and Probe Tubing/Body Assembly	42
Chapter 9: Cleaning/Shutdown Procedure	45
Required Kit Components	45
Cleaning Procedures	45

Overview of HTS Customer Care

About the HTS Customer Care Kits

The HTS Customer Care kits can help keep the BD High Throughput Sampler Option (HTS) in peak operating condition. The HTS will experience problems if sheath fluid crystallization occurs in the connectors, tubing, and syringes. Replacing these components every six months or annually, along with daily cleaning and fluidics cleaning and shutdown, can prevent clogs and optimize system performance. The HTS Customer Care Kit offers a convenient way to replace clogged connectors, tubing, and syringes on site. The kit, which contains customer-replaceable components and instructions, reduces downtime and the need for depot repair.

Kit Configurations

The HTS Customer Care Kit is designed to custom fit the HTS configuration for each cytometer or group of cytometers. Therefore, order the correct kit number by using the following table.

Part number	Description	Cytometer
644787	HTS Kit Parts Replacement	BD FACSCanto™ BD FACSCanto™ II
644788	HTS Kit Parts Replacement	BD FACSCalibur™ BD™ LSR II (including special order BD LSR II) Special order BD LSRFortessa™

When to Use the Kit

The parts in the HTS Customer Care Kit can be used to resolve common problems. The following table is lists of symptoms, possible causes, and solutions that are described in this user's guide.

Symptom	Possible Causes	Solution	See...
High carryover	Wash station connections are worn	Replace wash station components	Chapter 3
Secondary pump (Pump-2) error	Clog in sample coupler tubing, or in pump syringe, or syringe needs replacement	Replace sample coupler tubing or pump syringes	Chapter 5 Chapter 6
Primary pump (Pump-1) error	Clog in probe, or tubing assembly from probe to the primary pump, or in pump syringe, or syringe needs replacement	Replace probe, tubing assembly components, or pump syringes	Chapter 4 Chapter 6

Symptom	Possible Causes	Solution	See...
Wash station overflows	Wash station clog	Replace the wash station assembly	Chapter 3
No events detected	Clog in sample coupler tubing or tubing assembly	Replace tubing assembly components or sample coupler tubing	Chapter 5
Leak in sample coupler	Loose coupler or clog in coupler tubing	Tighten coupler (see precautions) or replace sample coupler tubing when necessary	Chapter 5
Reduced sheath flow	Sheath fluid filter is dirty or clogged	Replace fluidic filter every six months or when clogged	Chapter 7
Probe does not take up sample	Probe might be bent or clogged	Replace probe tubing assembly	Chapter 8

About the HTS

Illustrations of the HTS and a schematic of the fluidics system are provided for reference. For more detailed information, see your *BD High Throughput Sampler User's Guide*.

HTS Configurations

The following figures show the front and rear views of the HTS for each cytometer.

Figure 1-1 HTS for the BD FACSCanto II system



Figure 1-2 HTS for the BD FACSCalibur and BD FACSCanto systems

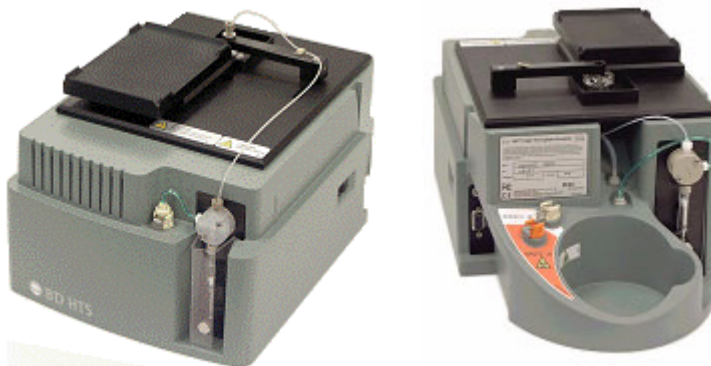

Note: The module body color for the BD FACSCanto is blue

Figure 1-3 HTS for the BD LSR II, special order BD LSR II and BD LSRFortessa systems



NOTE The main HTS module shown is the same for all BD LSR products. The BD LSRFortessa analyzer has an extra protective cover that mounts to the original BD LSR II HTS cover.

Location of Commonly Clogged Components

The clogs that occur and need repair are in the fluidics system. The following schematic identifies the most commonly clogged components. The numbers refer to component parts in the Required Kit Components tables throughout this guide.

Figure 1-4 Schematic of the HTS fluidics system

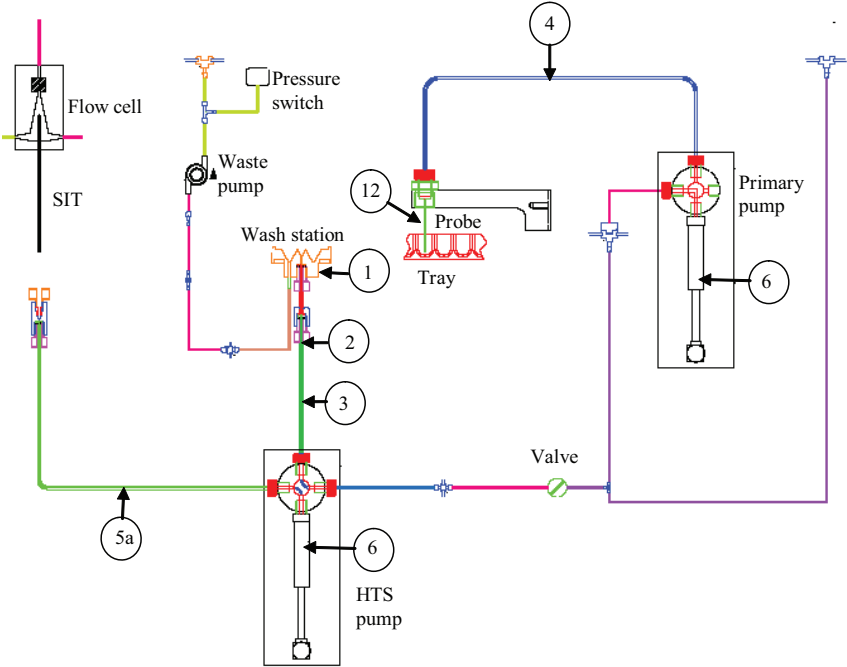

Safety and General Precautions

Biological Safety



All instrument surfaces that come in contact with biological specimens can transmit potentially fatal disease.



Use universal safety precautions when changing tubing or removing any part in contact with the fluidics system.

Wear suitable protective clothing, eyewear, and gloves.

Electrical Safety



Ensure that the power to the HTS is turned off before handling electrical cables and their connections.

Precautions

- 1 Tighten all fittings finger tight. Do not use tools to further tighten connectors.
- 2 If a connector is difficult to remove because of saline deposits, clean with deionized (DI) water, then carefully use the 5/16 wrench in the accessory kit to remove the connector.
- 3 The sealing washers in the valves of each port can be compressed, and will eventually block the port. To avoid compression, tighten fittings until they make contact with the sealing washer and then turn the fitting an additional 1/6 to 1/4 turn. If there is a leak, tighten the fitting no more than an additional 1/8 turn.

THIS PAGE INTENTIONALLY LEFT BLANK

HTS Removal and Reinstallation

Before performing replacement procedures, remove the HTS from the cytometer. Pay particular attention to the following:

- Always disconnect electrical connections (interlock cable and interface cable) and fluidic connections (waste, sheath, and sample injection tubing (SIT)).
- The waste and sheath fittings on the back side of the HTS can easily be broken when moving the HTS away from the cytometer while these fittings are connected. Move the HTS just enough (approximately 2 inches) to provide the room necessary to disconnect the waste and sheath fittings from the HTS.



All instrument surfaces that come in contact with biological specimens can transmit potentially fatal disease.

BD FACSCanto II System

Removing the HTS

- 1 Turn off the cytometer and HTS.
- 2 Remove or open the BD High Throughput Sampler safety cover.

- 3** Detach the sample coupler from the cytometer SIT.
 - a** Unscrew the top nut.
 - b** Pull the sample coupler down and away from the SIT, leaving the nut attached to the sample coupler.
- 4** Unscrew the captive screw located at the bottom of the HTS support bracket.
- 5** Pull the HTS out (about 2 inches) from the support bracket.
- 6** Remove the probe and the overflow reservoir.
- 7** Disconnect interlock and interface cables.
- 8** Disconnect the sheath and waste connectors from the HTS.
- 9** Disconnect the sampler coupler from the cytometer SIT.
- 10** Disconnect the door sensor cable.
 - a** Lift the front feet of the HTS just over the front edge of the enclosure and tilt the unit at a 45° angle toward you for access to the door sensor cable on the right side.
 - b** Unplug the door sensor cable by pulling back on the ferrule.
 - c** Place the cable over the right side of the enclosure/carrier.

- 11 Place the HTS unit on a stable work bench.

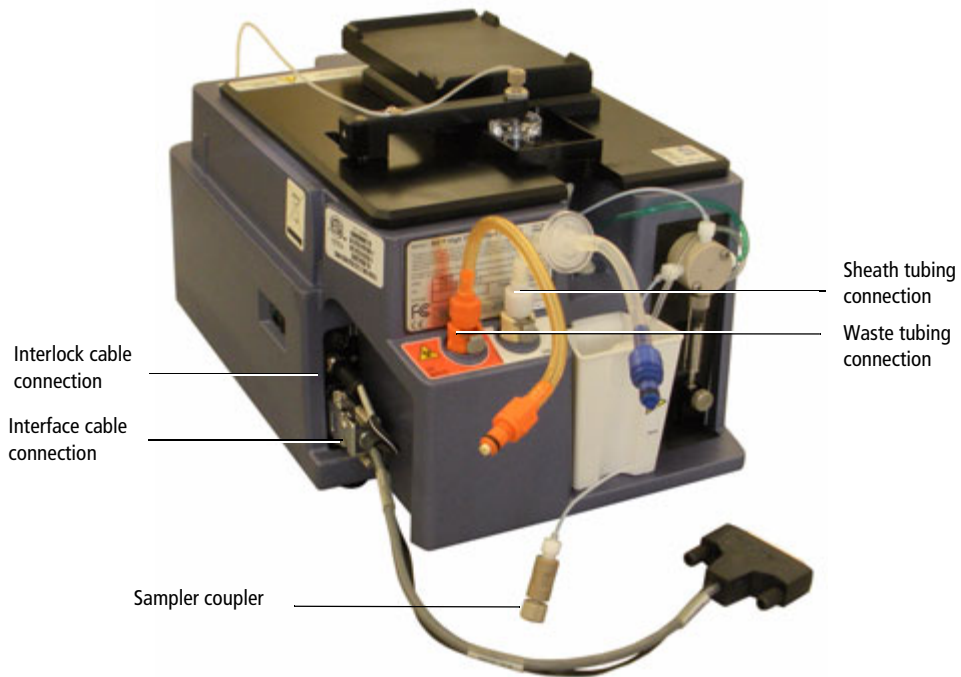

Reinstalling the HTS

- 1 Place HTS on support bracket.
- 2 Connect the interlock cable to the HTS.
- 3 Connect the interface cable to the HTS.
- 4 Connect the waste tubing to the waste connector on the HTS.
- 5 Connect the sheath tubing to the sheath connector on the HTS.
- 6 Connect the sampler coupler to the SIT on the cytometer.

- 7 Tighten the captive screw that secures the HTS to the support bracket.
- 8 Turn on the cytometer.

BD FACSCanto, BD LSR II, BD FACSCalibur, and BD LSRFortessa Systems

Removing the HTS

- 1 Turn off the cytometer and HTS.
- 2 Remove the HTS cover.
- 3 Unscrew the captive screw located at the bottom of the HTS support bracket.

NOTE There is no captive screw in BD LSRFortessa, because the HTS is placed on a sliding drawer.

- 4 Pull the HTS out (about 2 inches) from the support bracket.
- 5 Remove the probe and the overflow reservoir.
- 6 Disconnect the power cable and the serial communications cable.
- 7 Disconnect the sampler coupler from the cytometer SIT.
- 8 Disconnect the sheath and waste connectors from the cytometer.
- 9 Remove the HTS from the support bracket.
 - a Support the HTS on its base, raise the back of the HTS to balance the load, and lift it off the support bracket.
- 10 Place the unit on a stable work beach and replace the necessary part.

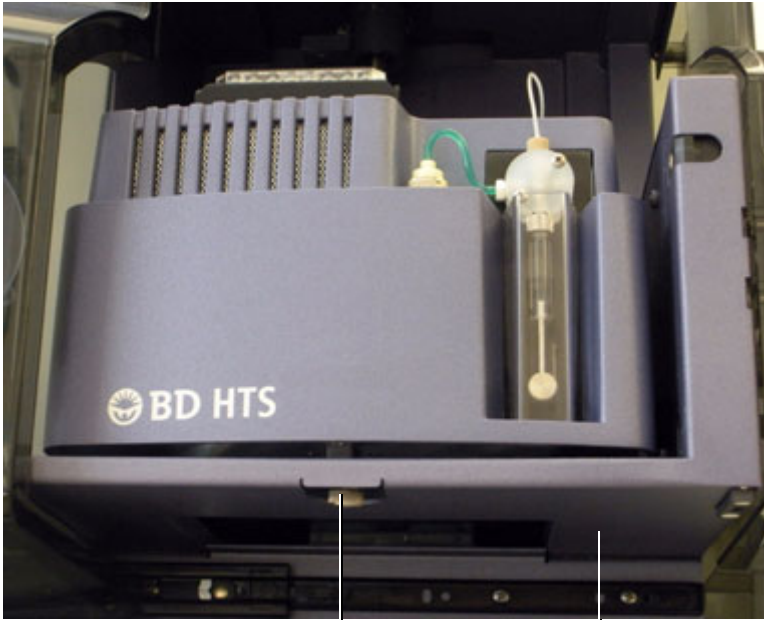

Captive screw

HTS positioned on its support bracket

Figure 2-1 Electrical connection to the HTS

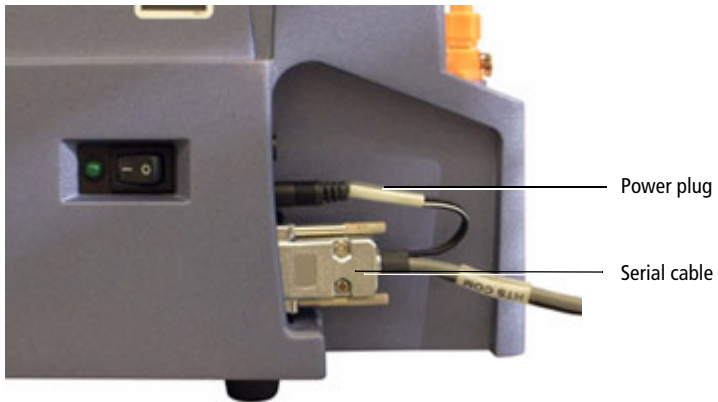
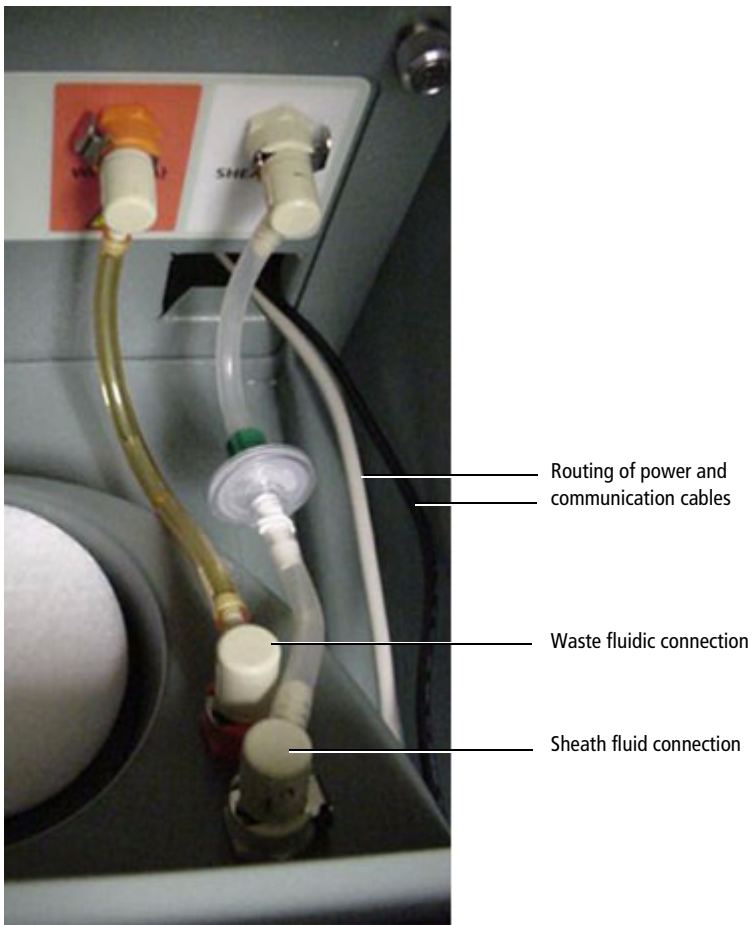

Figure 2-2 Fluidic connections to HTS



Reinstalling the HTS

- 1 Place the HTS on the support bracket.
- 2 Reconnect the power cable and the serial communications cable.
- 3 Reconnect the sheath and waste connectors to the HTS.

- 4 Slide the HTS unit as far as it can go.
- 5 Secure the mounting screw to the bottom on the HTS.
- 6 Place the cover back on the HTS and turn it on.
- 7 Attach the sample coupler to the SIT.
- 8 Turn on the cytometer.
- 9 Start BD FACSDiva™ software or Plate manager software if connected to the BD FACS Calibur and perform an HTS prime.

Wash Station Assembly Replacement

Perform the wash station assembly maintenance tasks every six months or when the following symptoms occur:

- The HTS exhibits higher than normal carryover between samples
- The wash station overflows

Required Kit Components

The sample injection tubing (3) connects the injection port/wash station (1) to the secondary pump valve (not shown).

Item number	Part Number	Description	Qty
1	336947	Injection port/wash station	1
2	335526	Tubing, injection port	1
3	335451	Tubing assembly, sample injection tubing to HTS pump	1

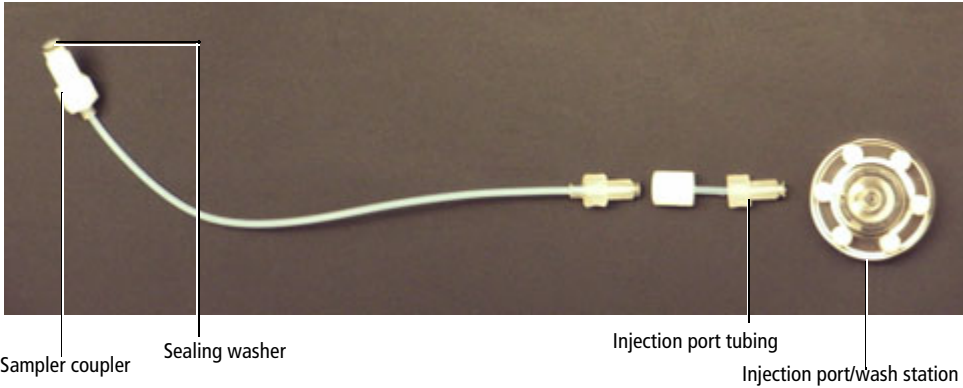

Replacing Wash Station Components

- 1 Perform the monthly cleaning procedure to decontaminate the sample injection port/wash station. For instructions, see your *BD High Throughput Sampler User's Guide*.
- 2 Turn off the cytometer and HTS if needed.
- 3 Remove the HTS according to procedure in Chapter 2.
- 4 Move the probe arm up and toward the front of the HTS.
- 5 Unscrew and remove the sample injection tubing from the top of the secondary pump.



The tubing nuts are normally finger tight. If it is difficult to unscrew a tubing nut, use a 5/16 wrench to loosen it.

- 6 Turn the sample injection port (see figure) slightly to disengage the magnets, and lift the port approximately 1 inch.
- 7 Disconnect the silicon tubing from the sample injection port. Do not disconnect the silicon tubing at the lower end because this could damage the lower connector.

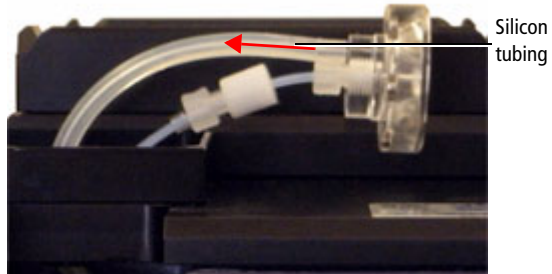

- 8 Secure the silicon tubing so that it does not slide back into the hole, and carefully remove the sample injection port assembly.

Assembling the Sample Injection Tubing Assembly



To prevent the cross-threading of fittings, ensure that mating fittings are aligned to one another before screwing them together. All fittings should be secured only finger tight and not beyond.

- 1 Connect the sample injection port to the sample injection port tubing assembly.



- 2 Connect the injection port tubing assembly to the sample injection tubing assembly.



- 3 Lower the sample injection port tubing assembly into the port hole and connect the silicon tubing to the sample injection port base (as shown in the following figure). The magnets will secure the sample injection port in place.

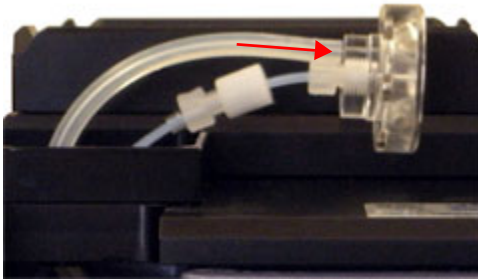

- 4 Install and tighten the sample injection tubing assembly to the top of the secondary pump and install the HTS on the cytometer (see Chapter 2).

THIS PAGE INTENTIONALLY LEFT BLANK

Tubing Assembly Replacement

Perform the tubing assembly from probe to the primary pump maintenance tasks when the following symptoms occur:

- Tubing is clogged
- The systems displays a primary pump (Pump-1) error
- No events are detected

Required Kit Components

Item number	Part Number	Description	Qty
4	335454	Tubing assembly, sample probe to the primary pump	1

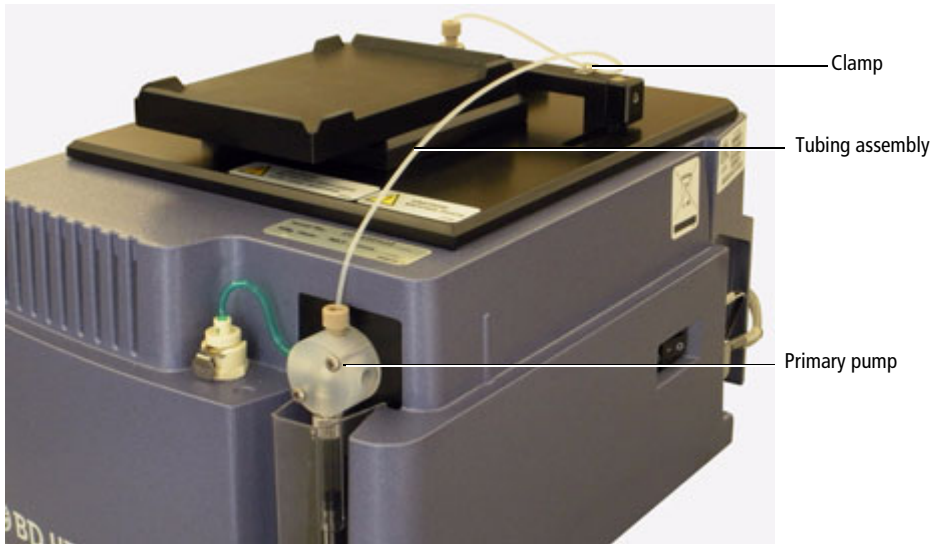

NOTE Use caution when handling the sample injection port assembly. This assembly is fragile and can be easily damaged.

Replacing Tubing Assembly Components

- 1** Turn off the cytometer and HTS and move the sample probe into the sample injection port.
- 2** Remove the sample probe tubing assembly.
- 3** Unscrew the sample injection tubing from the probe and the top of primary pump.

The sample injection tubing connectors are indicated in the following figure.

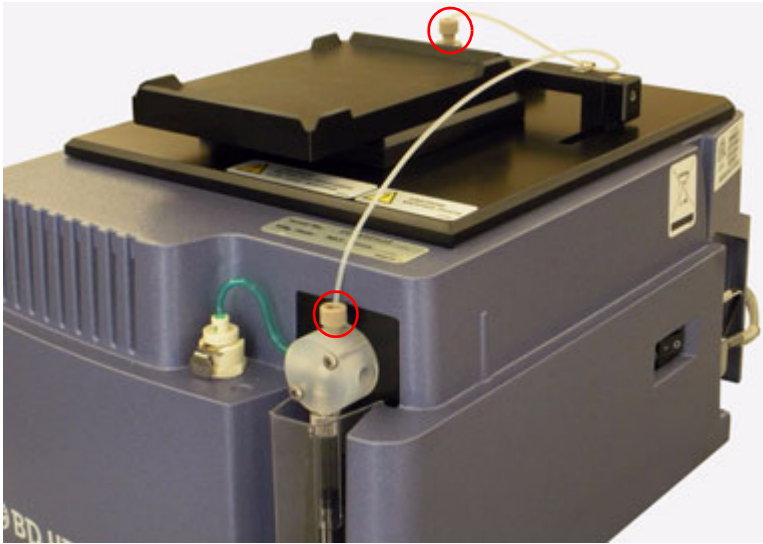

4 Remove the sample probe tubing by rotating the tubing clamp on the arm to allow enough clearance for the tubing to be removed. If a connector is difficult to remove due to saline deposits, clean it with DI water. If it still does not unscrew, then carefully use the 5/16 wrench and gently loosen the clamp. Do not force.

5 Connect the sample probe tubing.

NOTE Valves contain sealing washers in each port. If you over-tighten the fitting, the sealing washers can be compressed, resulting in a blocked port. Tighten the fitting until it contacts the sealing washer, and then turn the fitting an additional 1/6 to 1/4 turn. If leaking is observed, tighten the fitting no more than an additional 1/8 turn.

6 Install the sample probe tubing in the clamp on the arm and rotate the clamp back into position.

7 Install and tighten the sample injection tubing to the sample probe and to the top of the primary pump.

8 Turn on the cytometer and perform a Prime.

THIS PAGE INTENTIONALLY LEFT BLANK

Sample Coupler and Tubing Replacement

The sample coupler is frequently installed or removed from the SIT to run the cytometer in tube acquisition mode. The sample coupler tubing is attached to the HTS secondary pump.

Replace the sample coupler tubing annually or when the following symptoms occur:

- The system displays a secondary pump (Pump-2) error
- The sample coupler continues to leak after being tightened

A rare symptom can be no events are detected.

BD FACSCanto and FACSCanto II Systems

Item number	Part number	Description	Qty
5	339340	Sample coupler, secondary pump to SIT	1

Figure 5-1 Sample coupler and tubing for the BD FACSCanto and BD FACSCanto II systems

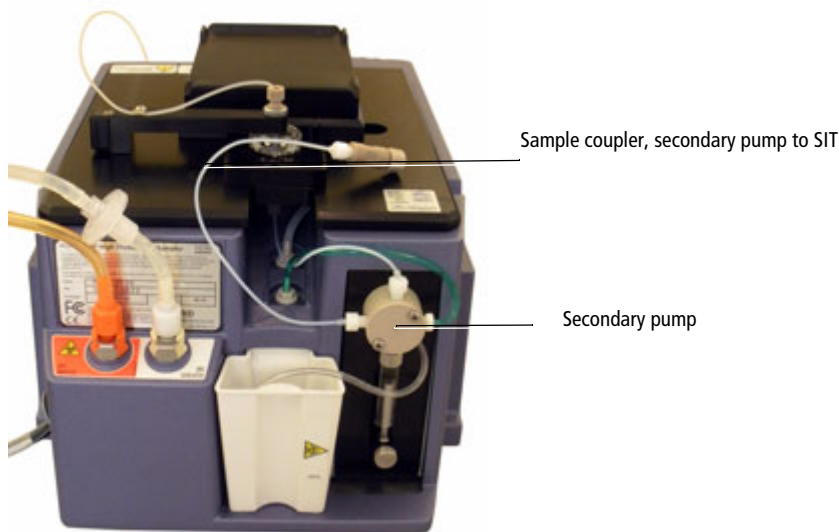

- 1 Turn off the cytometer, and remove the HTS from the cytometer (see Chapter 2).
- 2 Unscrew the sample coupler tubing from the left port of secondary pump valve (indicated in the figure) and discard the sample coupler with tubing into a biohazardous waste container.

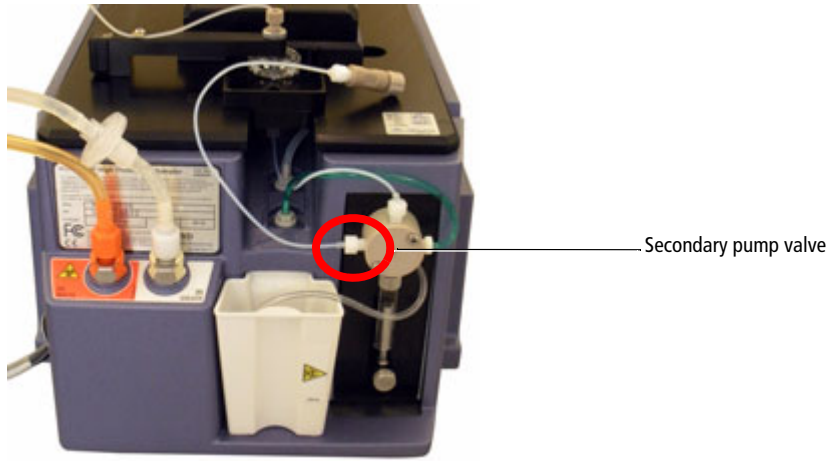

- 3 Install the new sample coupler tubing provided in the HTS Customer Care Kit.
- 4 Connect the new tubing to the left port in the secondary pump valve, and tighten the tubing until the fitting is finger tight.

NOTE Valves contain sealing washers in each port. If you over-tighten the fitting, the sealing washers can be compressed, resulting in a blocked port. Tighten the fitting until it contacts the sealing washer, and then turn the fitting an additional 1/6 to 1/4 turn. If leaking is observed, tighten the fitting no more than an additional 1/8 turn.

- 5 Install the HTS on the cytometer (see Chapter 2).

BD FACSCalibur, BD LSR II, or BD LSRFortessa Systems

Item number	Part number	Description	Qty
5a	335452	Sample coupler, secondary pump to SIT	1

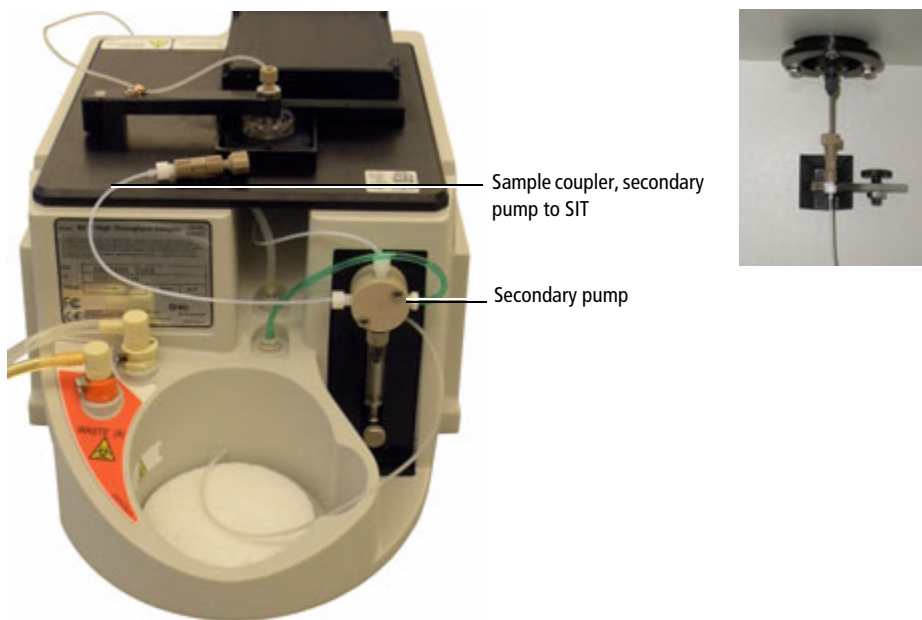

- 1 Fill a small, clean container with approximately 300 mL of DI water.
- 2 Remove the sheath line from the HTS.
- 3 Connect the purge tubing to HTS sheath port (see Chapter 9).

Pump Syringe Replacement

Glass syringes are used in the primary and secondary pumps of the HTS unit. For reference, the syringe associated with the secondary pump is shown in the following figure.

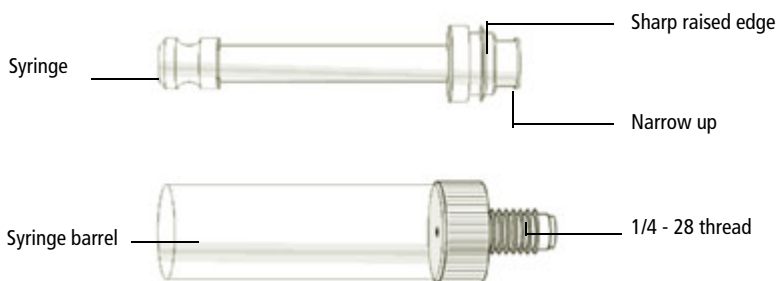

Perform the replacement of the pump syringe maintenance tasks annually or when the following symptoms occur:

- Primary or secondary pump (Pump-1 or Pump-2) errors occur
- A Pump syringe has a clog

NOTE It is not necessary to remove the HTS when replacing the primary pump syringe (located on the front of the HTS). However, it is necessary to remove the HTS when replacing the secondary pump syringe (located on the rear of the HTS).

Required Kit Components

Item number	Part number	Description	Qty
6	344912	Syringe, 500 µL, with black plunger seal	1
7	347306	Lubricant, O-ring, Super O-Lube, ½-ounce tube	1

Pump Syringe Replacement Procedures

- If you are replacing the primary pump, use both procedures in this chapter.
- If you are replacing the secondary pump, remove the HTS (see Chapter 2), then use the Replacing the Syringe procedures.

Removing Liquid from the Syringe (For Primary Pump Syringe)

- 1 Verify that the cytometer and BD FACSDiva software are running.
- 2 From the Acquisition Dashboard select **RUN PLATE**.
- 3 Remove the liquid from the syringe:
 - a Disconnect the sheath connector from the back of the HTS.
 - b Disconnect one end of the sheath filter.
 - c Select **HTS > Prime**.
 - d Repeat until the syringe barrel is empty.
 - e Exit BD FACSDiva software.
- 4 Turn off the cytometer.

Replacing the Syringe

- 1 Loosen the plunger lock screw (indicated in the following figure) approximately three full turns.

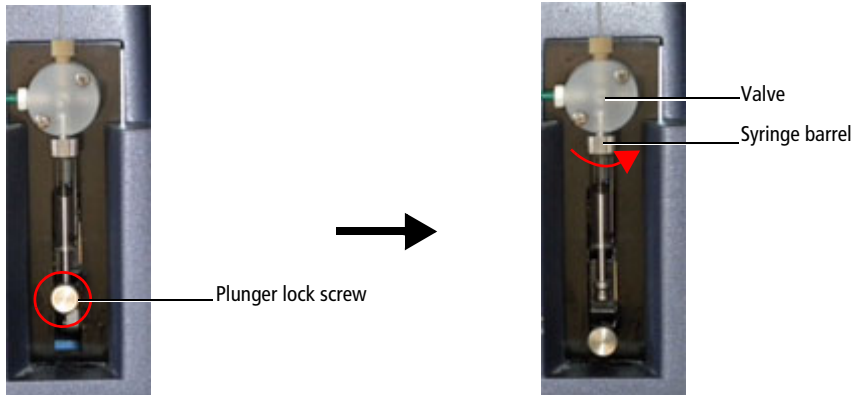

- 2 Lower the plunger drive by pushing the plunger lock screw down.
- 3 Unscrew the syringe barrel and remove it from the lower part of the valve. Grasp the metal ring at the top of the syringe and turn counterclockwise.
- 4 Discard the used syringe into a biohazard sharps container.
- 5 Install the new syringe:
 - a Screw the syringe barrel onto the valve until it contacts the seal washer, then turn the syringe an additional $1/6$ to $1/4$ turn. If you observe a leak, tighten a maximum of an additional $1/8$ turn.
 - b Pull the syringe plunger down to the plunger holder (see the following figure).

- c** Tighten the plunger lock screw, making sure it is securely tightened.

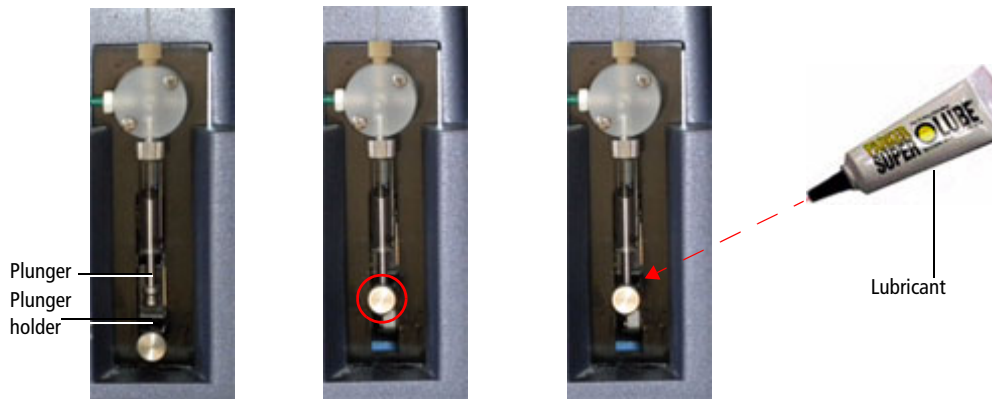

- 6** Apply a generous amount of O-ring lubricant to the plunger lock screw to prevent seizing in the future. You can apply the lubricant in the lock lever hole before placing the plunger in it. This will help keep the saline out of the whole assembly Do not lubricate the syringe barrel.
- 7** For the secondary syringe, reinstall the HTS on the cytometer (see Chapter 2).

- 8 Turn on the cytometer and using the BD FACSDiva software, perform a Prime.

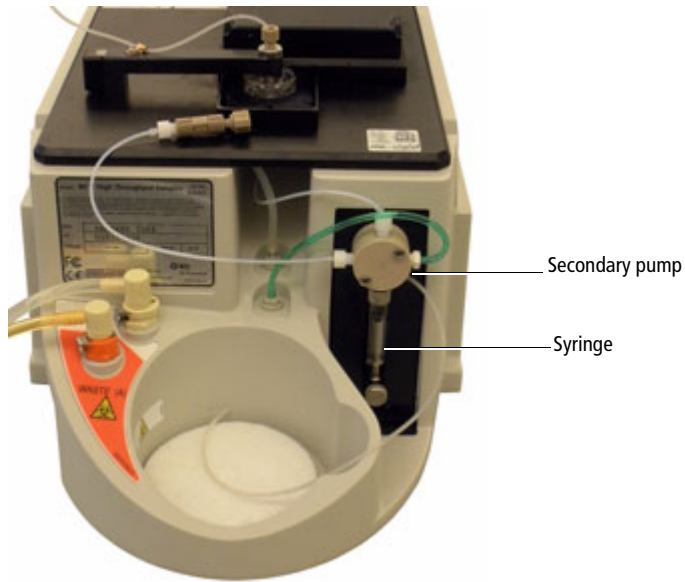

THIS PAGE INTENTIONALLY LEFT BLANK

Fluidic Connection and In-line Fluidic Filter Replacement

This chapter covers the replacement of the two fluidic connections between the cytometer and the HTS. These two fluidic connections are sheath and waste connections.

Perform the fluidic connections maintenance and replace the sheath filter:

- Every six months
- When the sheath flow is reduced or inadequate

Required Kit Components

Item number	Part number	Description	Qty
8	335710	Filter, 25 mm, 17- μ m screen	1
9	343527	Coupling insert, hose barb (blue)	1
10	59-10090-05	Coupling insert, hose barb (orange) (waste)	1
11	343529	Coupling insert, hose barb (white)	1

Figure 7-1 Filter

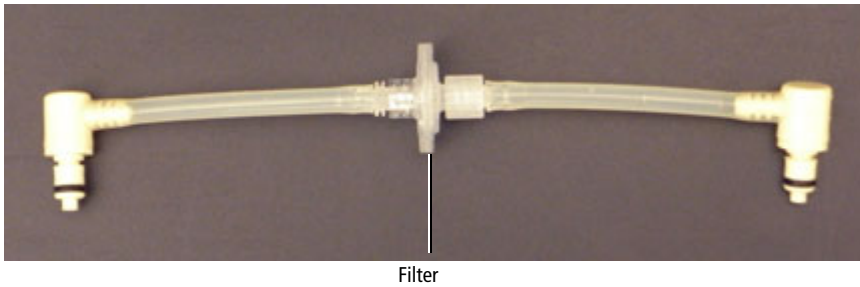
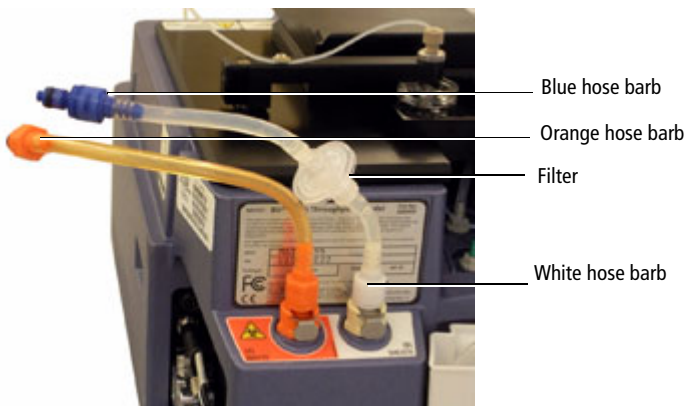
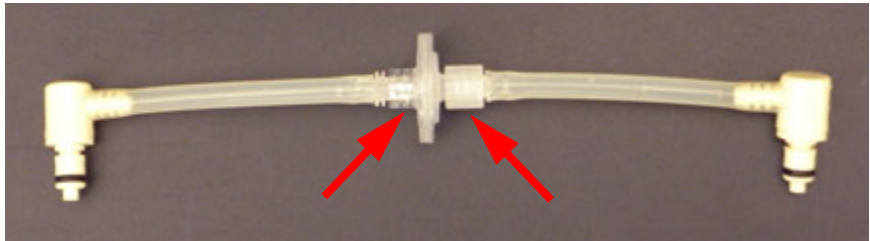

Figure 7-2 BD FACSCanto II connectors



Replacing the Filters

- 1 Turn off and remove the HTS from the cytometer (see Chapter 2).
- 2 Replace the two liquid connections between the cytometer and the HTS:
 - a Move the HTS away from the cytometer to provide access behind the HTS.
 - b Disconnect the quick-connector at the cytometer interface panel and the back of the HTS (orange quick-connector end in Canto II).
 - c Disconnect the quick-connector at the cytometer interface panel and at the white quick-connector on the back of the HTS unit (blue quick-connector end in Canto II).
 - d Remove the tubing from the filter by twisting the Luer connections.



- e Install the sheath line with the lock-ring end toward the cytometer panel.

This will prevent foreign material that accumulates on one side of the filter from flushing into the HTS if the filter is reversed.
- 3 Replace the filter and reconnect all tubing.
- 4 Install the HTS on the cytometer (see Chapter 2).

THIS PAGE INTENTIONALLY LEFT BLANK

Probe and Probe Tubing/Body Assembly Replacement

The probe is located at the end of the probe assembly arm.

Replace the probe along with the probe tubing or body assembly annually, or when the following occurs:

- Probe is bent or is not taking up sample
- Probe is clogged

Required Kit Components

Item number	Part number	Description	Qty
12	34389017	Probe tubing/body assembly	1

NOTE A spare probe is included in the HTS accessory kit.

Replacing the Probe and Probe Tubing/Body Assembly



The sample injection port is fragile and can be easily damaged. Use care when handling the sample injection port.

- 1 Turn off the cytometer and remove the HTS cover.

NOTE On the BD FACSCanto, BD LSR II, and BD FACS Calibur systems, you will need to turn off the power on the cytometer and the HTS separately.

- 2 Pull the HTS arm up slowly and move it toward the front of the instrument.

Probe
tubing/body
assembly



- 3 Unscrew the tubing connector from the probe.

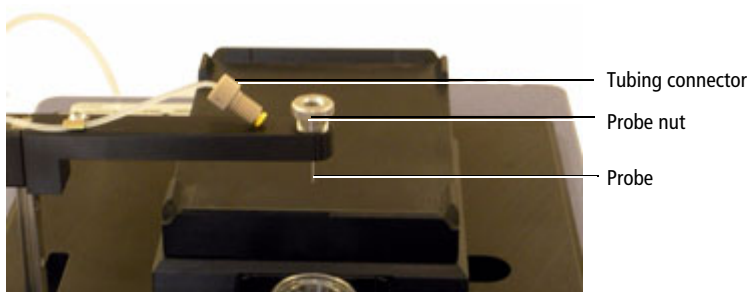

- 4 Unscrew the probe nut and remove the probe from the arm.

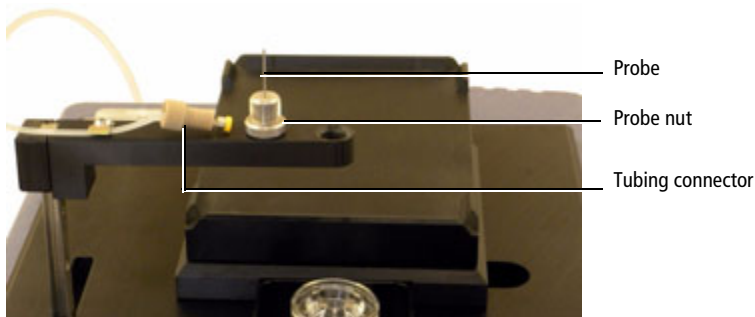

- 5 Install and tighten a new probe.
 - a Tighten the probe nut at the top of the probe and attach the tubing connector to the probe.
- 6 Turn on the cytometer and HTS if needed.
- 7 Start BD FACSDiva software and perform an HTS prime.

THIS PAGE INTENTIONALLY LEFT BLANK

Cleaning/Shutdown Procedure

The BD FACSCalibur, BD LSR II, and BD LSRFortessa do not have a Fluidic Shutdown cycle that automatically replaces BD FACS™ sheath solution with BD FACS shutdown solution or DI water. These procedures are for the BD FACSCalibur, BD LSR II, Special Order BD LSR II, and Special Order BD LSRFortessa systems as they do not have a fluidic shutdown cycle built into the software.

We recommend daily cleaning and maintenance of the sample coupler and tubing to avoid clogs.

Required Kit Components

Item number	Part number	Description	Qty
13	340088	HTS purge tubing	1

Cleaning Procedures

- 1 Fill a clean container with approximately 300 mL of deionized (DI) water.
- 2 Remove the sheath line from the HTS.
- 3 Connect the purge tubing to the HTS sheath port.



HTS purge tubing

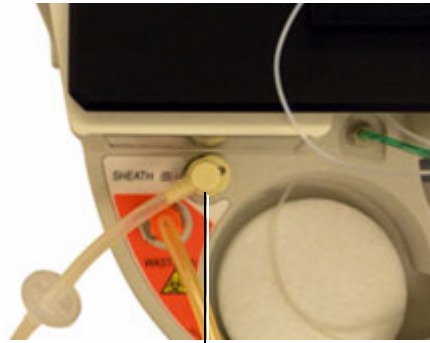

BD HTS sheath port

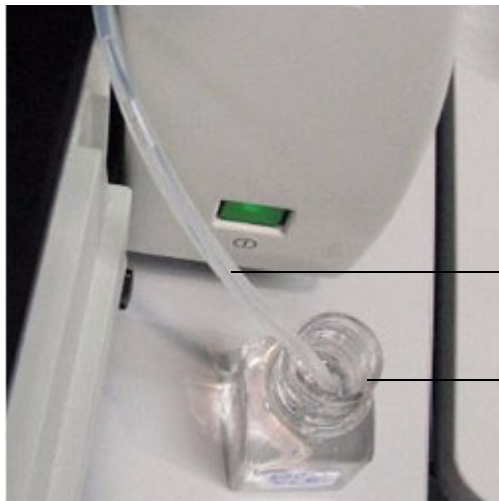

Purge tubing

DI water

- 4 Submerge the other end of the purge line into the DI water.
- 5 Using BD FACSDiva software, perform a system prime. Repeat 3 times.
For BD FACS Calibur, use BD Plate Manager software to run the prime.
- 6 Remove the purge tubing.
- 7 Reinstall the sheath line.